

Packaged Air-Conditioner Optional Parts



Base Heater PAC-SJ10BH-E

Before installation

- This product is designed for prevention of ice on the bottom of the outdoor unit heat exchanger and the clogged drain hole caused by freezing in severe winter.
- To drain properly, a drain socket and a concentrated drain pan are not allowed to be used with this product.

SAFETY PRECAUTIONS

- Carefully read this section 'Safety Precautions', and securely install the optional parts.
- Be sure to observe the cautions described here: They include critical contents for safety.
- The following indications show the classifications for danger, and possible consequences following incorrect handling.

 WARNING	Incorrect handling could lead to death or serious injury.
 CAUTION	Incorrect handling could lead to injury or damage to house and household articles.

- After installation, perform a test run and make sure that there is no abnormality, and ask your customer to keep this installation sheet with the installation manual at all times. Also ask the customer to transfer these manuals to a new user if the user changes.

WARNING

Ask the dealer or specialist for installation.

- If installed incorrectly by user, water leak, electric shock, fire, etc. could result.

Use the provided parts and the specified parts for installation.

- Improper parts could cause electric shock, fire, water leak, and injury caused by fall of the unit.

Mount the service panel on the outdoor unit securely.

- Incomplete installation may result in electric shock and fire caused by dust, water, etc.

Carefully install the optional parts according to this installation sheet.

- Incorrect installation could cause water leak, electric shock, fire, etc.

Use the specified electric wires. Connect and fasten the electric wires securely to the terminals so external force on the wires will not apply on the terminals.

- Improper connections and fastening could cause fire.

CAUTION

Do not install the unit where flammable gas may exist or leak.

- If the flammable gas should leak and accumulate around the unit, explosion may result from it.

Install an earth leakage breaker.







- Failure to install an earth leakage breaker may result in electric shock.

Ground the unit correctly.

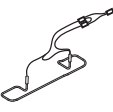
- Do not connect the ground wire to a gas pipe, a water pipe, a lightning rod, or a telephone ground wire. Improper grounding may cause electric shock.

1 Accessories

This package includes the following parts besides this installation sheet.

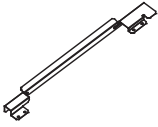
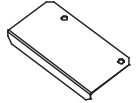
① base heater	1	② heater supports	2	③ screws 4×10	8	④ cable ties	5	⑤ fasteners	2
									
⑥ spec label	1	⑦ base heater cover(1) *	1	⑧ base heater cover(2) *	1	* Used solely with the outdoor unit mounted with a two-row heat exchanger.			
									

2 Preparation

It is easier to mount the base heater before installing the outdoor unit.

- Make sure that the main power supply to the unit is OFF.
- Do not lose the removed screws. Many screws will be removed to install the base heater.
- Eliminate dust, dirt, etc.

3 Preparation for mounting the base heater

Before mounting the base heater, follow the procedures below to remove some parts from the outdoor unit.

- Removal of service panel**
Remove 3 screws on the front. Slide the service panel downward to remove it.
- Removal of top panel**
Remove 2 screws on the front and 3 screws on the back. Lift the top panel up to remove it.
- Removal of screws for cover panel**
Remove 2 screws for the cover panel.
- Removal of front panel**
Remove 7 screws on the front. Slide the front panel upward, and pull it toward you.
- Removal of fan**
Remove the mounting screws for the fan. Pull the fan toward you to remove it.
- Removal of motor support**
Disconnect the connector of the fan motor, and remove 2 mounting screws for the motor support. Slightly pull the motor support toward you and lift it up to remove it.

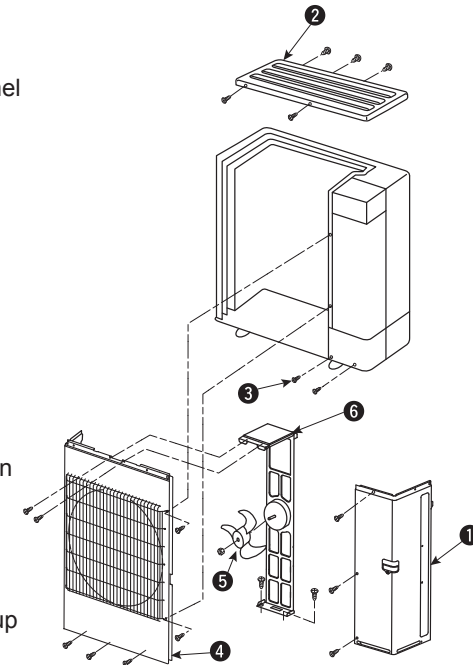

4 Mounting the base heater

- Temporarily place the base heater ① on the base so that the square hole for the motor support on the base comes to the center of the base heater ①. (See photo below.)



- Affix the base heater ① with the heater supports ② and the screws 4×10 ③.

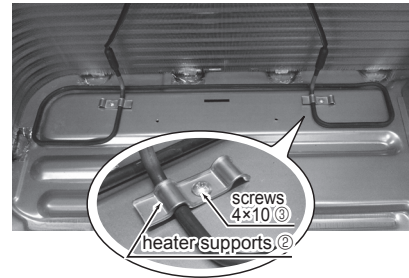
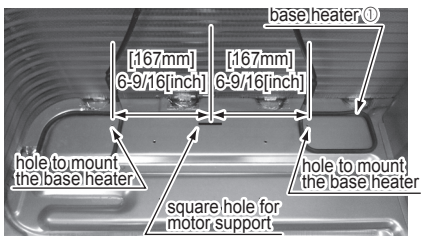

5 Mounting the base heater cover

Place the base heater covers ⑦, ⑧ as shown in the right photo.

Affix them with the screws 4×10 ③.

- Make sure to install the base heater covers ⑦, ⑧ in the outdoor unit mounted with a two-row heat exchanger. The base heater covers ⑦, ⑧ cannot be installed in the outdoor unit mounted with a three-row heat exchanger.

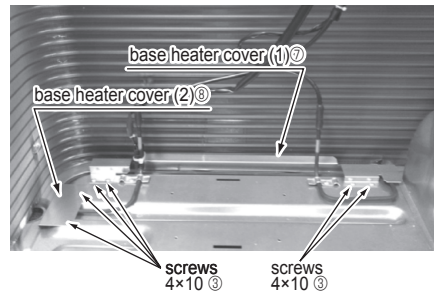

6 Mounting the motor support

Mount the motor support.

- Make sure that the lead wire is not caught between the bottom of the motor support and the base.

7 Securing the lead wires

- Pass the cable ties ④ through the holes. Affix the lead wires of the base heater to the motor support with the cable ties ④ at the positions shown in photo 1.
- Bundle the lead wires of the base heater and the fan motor together using the clamp on the motor support.
- Bundle the lead wires with the cable tie ④.
- Pass the lead wires through the circular hole on the separator toward the electrical parts box.
 - Secure the lead wires so they will not interfere with the propeller fan.

<Photo 1>

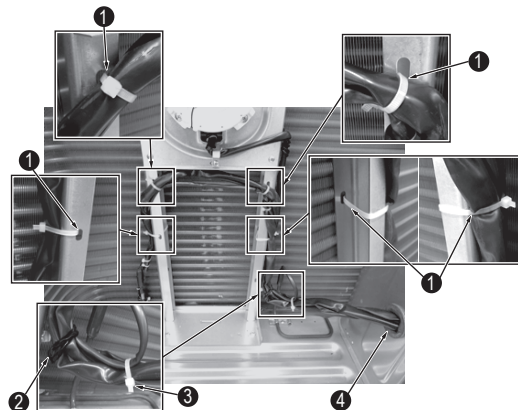

- Affix the lead wires and the other lead wires with the clamps on the separator at the positions shown in photo 2.

<Photo 2>

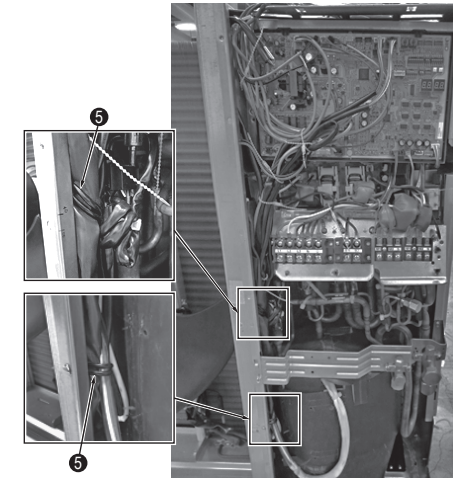

Wiring diagram

Connect the lead wires according to the following wiring diagram.

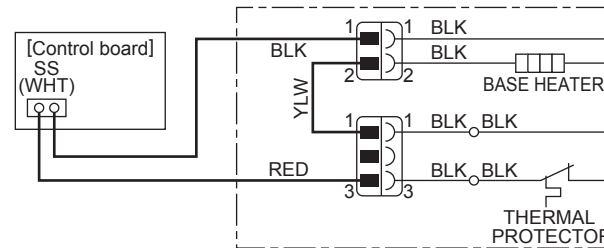

8 Securing the lead wires

After connecting the lead wires, bundle the extra lead wires together and secure them with the fastener ⑤.

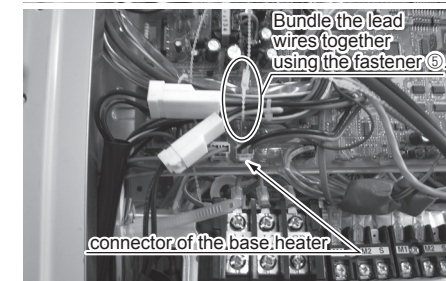

9 Attaching the spec label

Attach the spec label ⑥ above the spec name plate on the service panel.

10 Reinstallation

Make sure that the installation of the base heater and connections of the lead wires have been completed according to this installation sheet. Install the removed parts in the reverse order of removal.

- Tighten the propeller fan with a torque of $5.7 \pm 0.3 \text{ N} \cdot \text{m}$ [$4.2 \pm 0.2 \text{ ft} \cdot \text{lbs}$] ($57 \pm 3 \text{ kgf} \cdot \text{cm}$).
- Rotate the propeller fan and make sure that the base heater and the lead wires do not interfere with the movement of propeller fan.

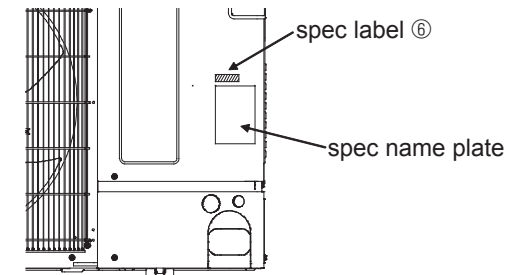

! WARNING

Mount the outer panels securely. Incomplete installation may result in electric shock and fire caused by dust, water, etc.